

ETİ MADEN İŞLETMELERİ GENEL MÜDÜRLÜĞÜ  
KIRKA BOR İŞLETME MÜDÜRLÜĞÜ

YÜRÜRLÜK TARİHİ : 15.11.2013

REVİZYON NO : 00

LAMİNELİ POLİPROPİLEN BAFFLE TORBA NORMAL SAPLI ALTTAN BOŞALTMALI

AMBAR STOK NO :

SAYFA NO : 1

BASKI RENGİ : PANTONE 661 PC

BOYUTU 1050 X 1050 X 1200 mm

AĞIRLIĞI : 1000 KGS

## ÖN, ARKA VE YAN YÜZ GÖRÜNÜŞÜ

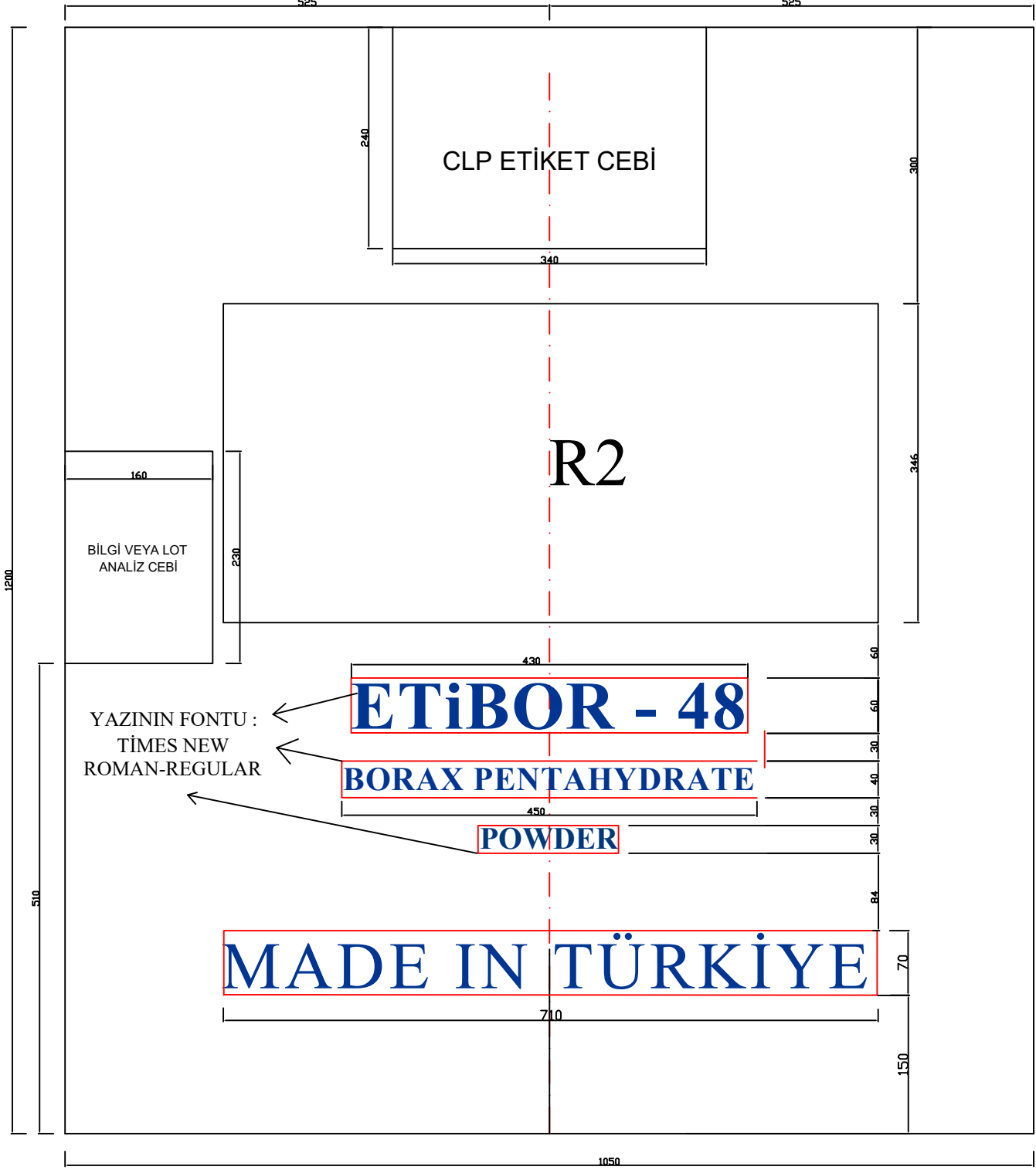

ÇİZEN VE HAZIRLAYAN  
NEŞET CAN  
AMBALAJ MALZEMESİ SORUMLUSU

ONAY  
CÜNEYT AKSAK  
STOK VE SEVKİYAT  
BİRİM SORUMLUSU

## PERSPEKTİF GÖRÜNÜŞ

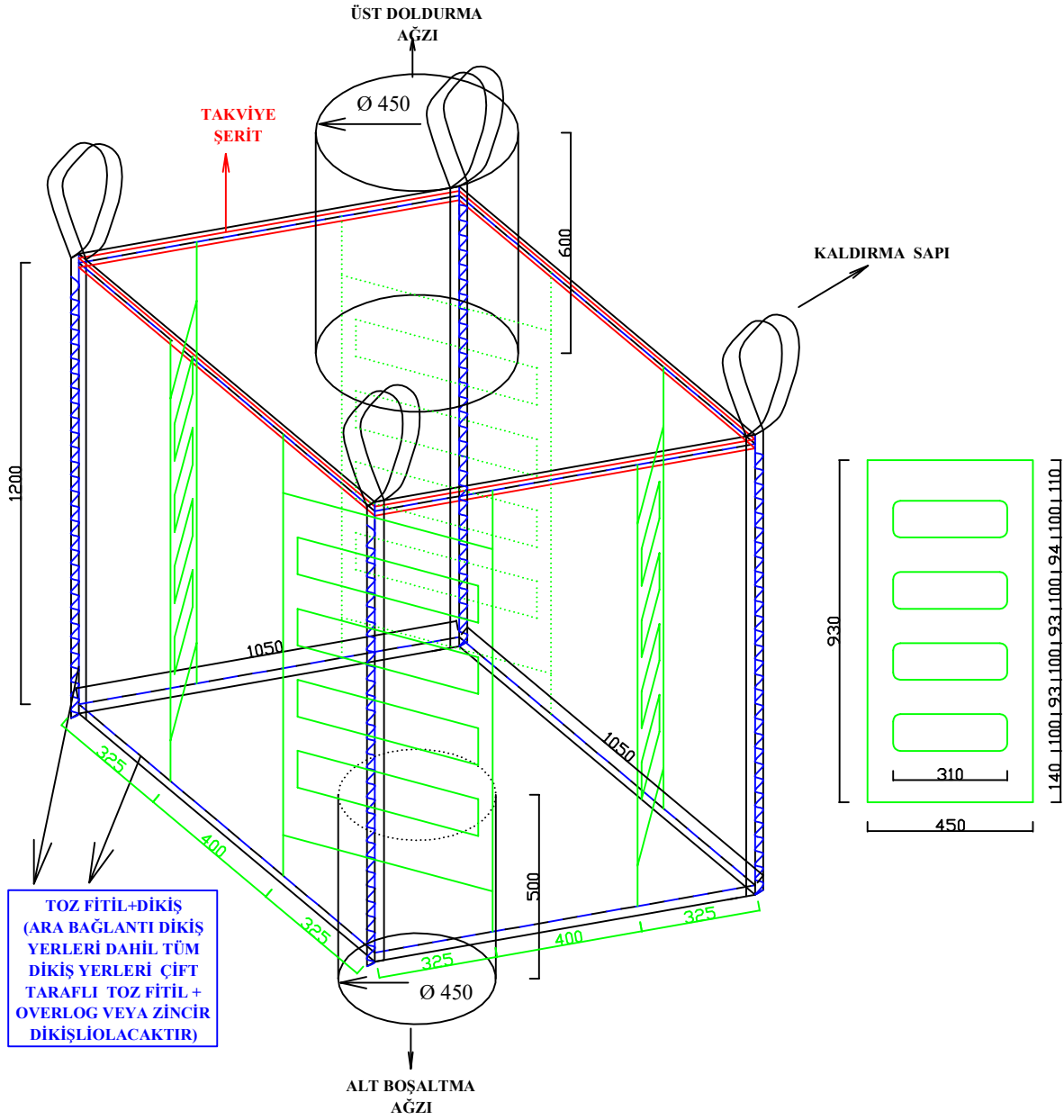

NOT :TEKNİK RESİM VE EKLERİNDEKİ TÜM ÖLÇÜLER mm'DİR

ÇİZEN VE HAZIRLAYAN  
NEŞET CAN  
AMBALAJ MALZEMESİ SORUMLUSU

ONAY  
CÜNEYT AKSAK  
STOK VE SEVKİYAT  
BİRİM SORUMLUSU

## ÜST DOLDURMA BACASI

## PERSPEKTİF GÖRÜNÜŞ

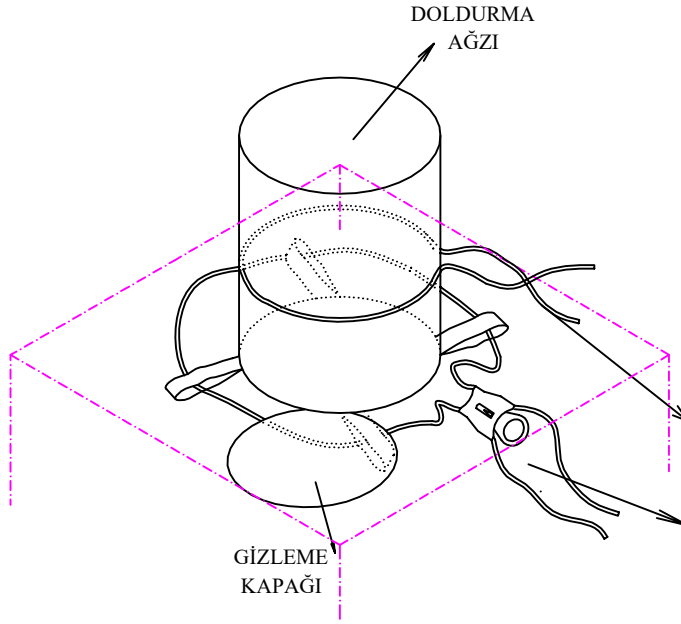

## ÜSTTEN GÖRÜNÜŞ

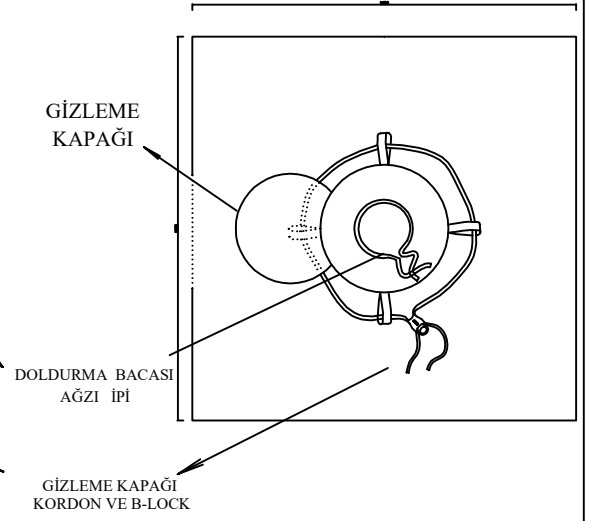

## ALT BOŞALTIMA BACASI

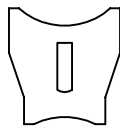
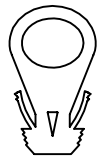
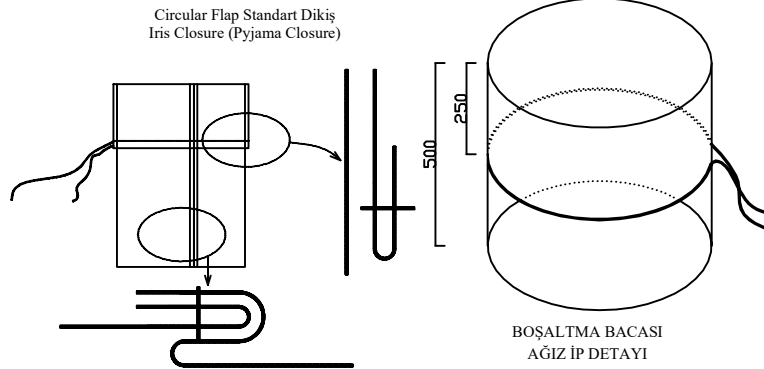

## B-BLOCK

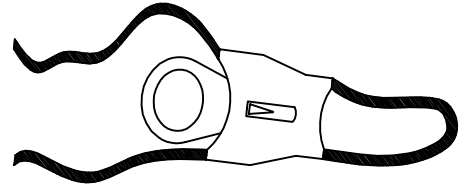

ÇİZEN VE HAZIRLAYAN  
NEŞET CAN  
AMBALAJ MALZEMESİ SORUMLUSU

ONAY  
CÜNEYT AKSAK  
STOK VE SEVKİYAT  
BİRİM SORUMLUSU